

CORMACH

27500 E

A.S.C. plus

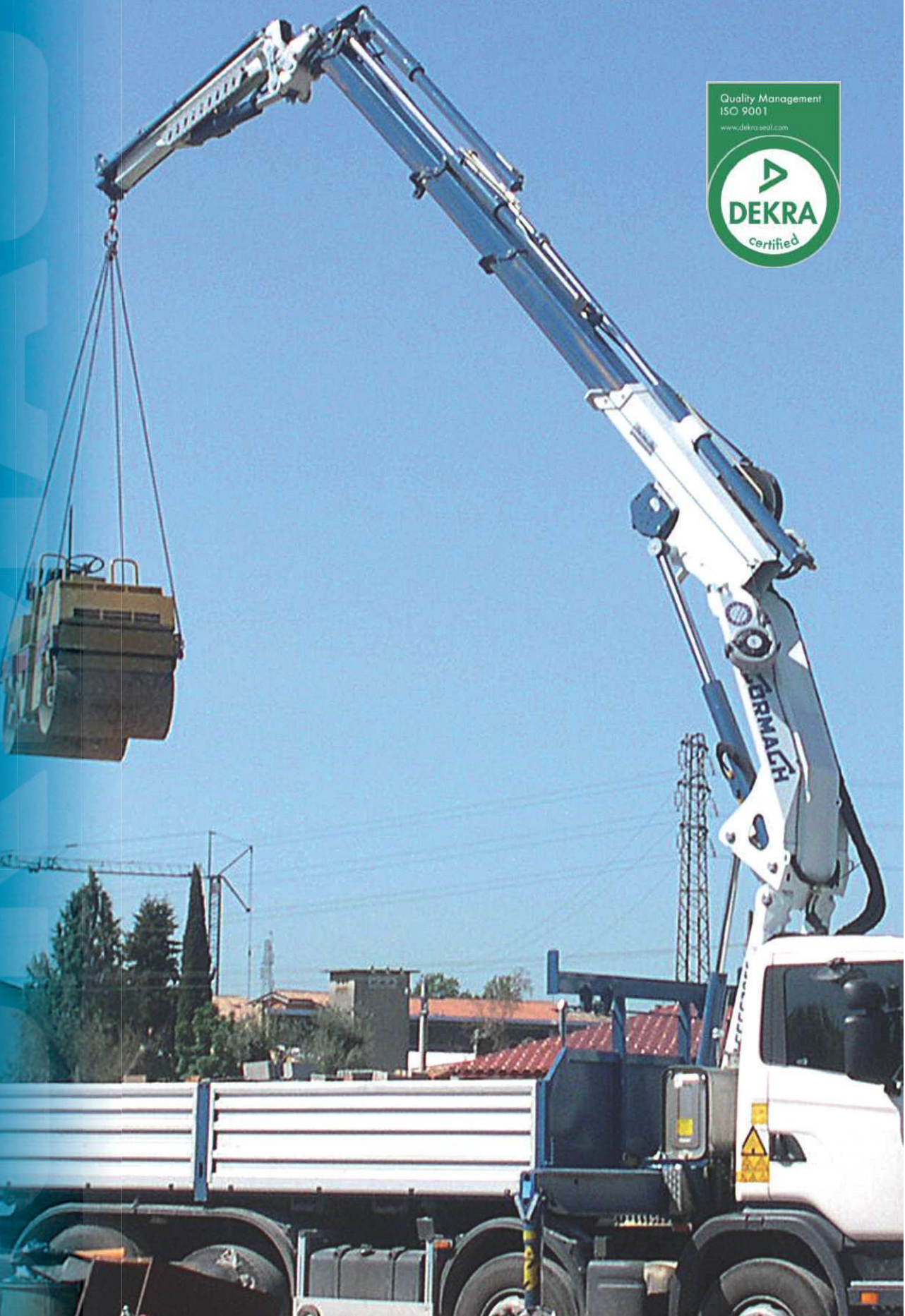

www.cormach.com



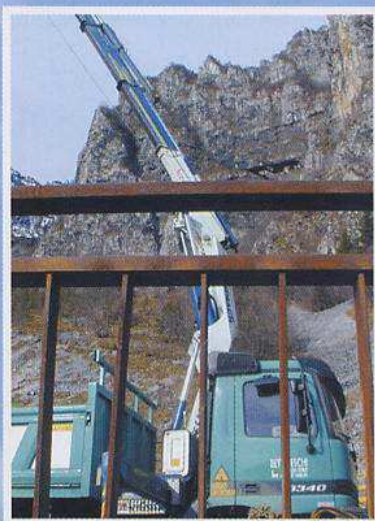

27500

A.S.C. plus

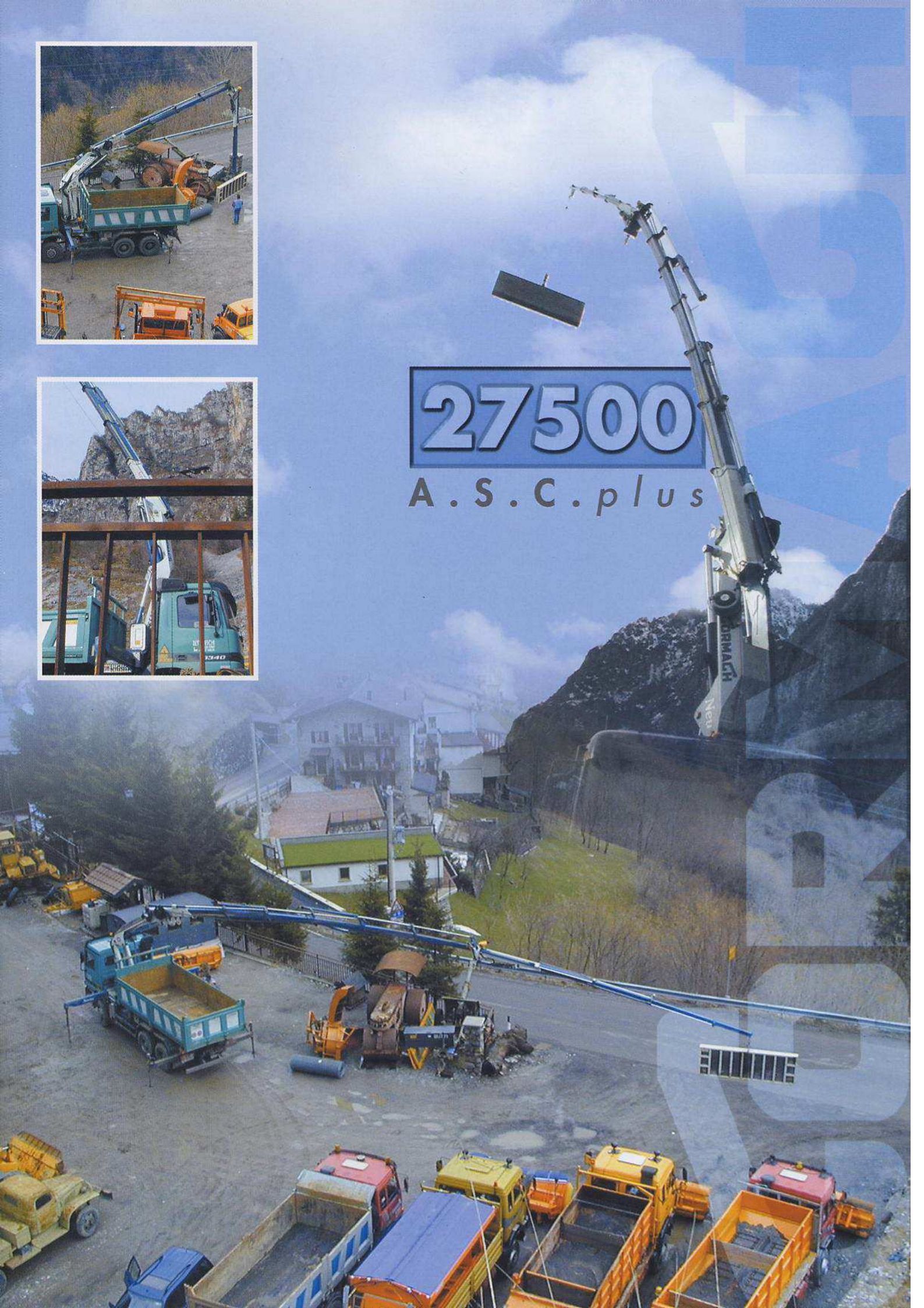

... ABOUT ANCIENT

EGYPT MANUSCRIPTS



KRANKAMON, PHAROAH OF EGYPT, DREAMED ABOUT HIS PYRAMID, THAT IN HIS INTENT, SHOULD BECOME THE BIGGEST EVER BUILT.

"Phew! What hard work. Is it possible that anybody can think of a better pushing system?"

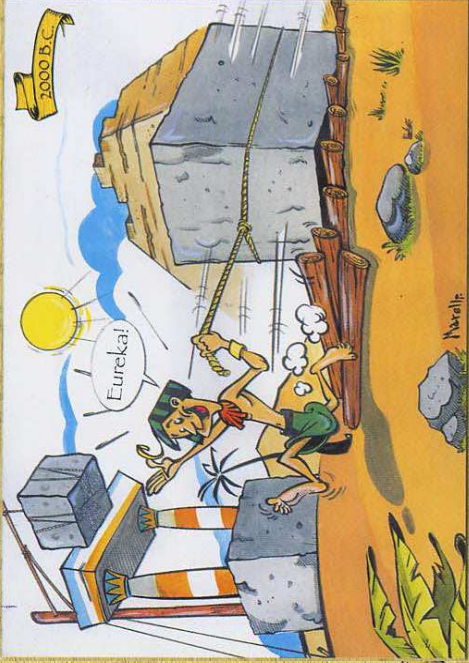

PHAROAH CORMISES, YEARS LATER, DREAMED THE SAME DREAM, OF THE BIGGEST PYRAMID BEING HIS OWN.

"Here is the solution: Cormach system with roller-bearing, faster and more efficient."



THE BUILDING PROCESS WAS SLOW BEING HIS RESOURCES LIMITED TO SLAVES AND MATERIAL.

"But, why is it such hard work using only one support?"



BEING OLD HE DECIDED TO FINISH KRANKAMON WORK, BUT HE NEEDED SOMETHING TO SPEED THE WORK UP.

"Here is the solution: Cormach system with double mast and double lifting cylinders."



THE PHAROAH LIVED A SHORT AND HARD LIFE AND THE KRANKAMON PYRAMIDS REMAINED A DREAM.

"There is something illogical in this system. The offset boom unbalances the structure."



CORMISES DREAM CAME THROUGH AND HIS PYRAMID WILL STAND FOR EVER.

"Here is the solution: Cormach boom in central position makes the structure more balanced. Excellent."

END



- Compattezza: 25,76 m di braccio idraulico 28 t*m di capacità' in uno spazio di 1x2.5x2.2 m
- Compactness: hydraulic operated forward reach 25,76 m. Capacity 28 t*m (202,563 lb*ft) with size 1x2.5x2.2 m (3'3"x8'2"x7'4").
- Compacité: rayon d'action hydraulique à 25,76 m. Capacité 28 t*m avec dimensions 1x2.5x2.2 m
- Kompakte bauweise: einbaumasse 1x2.5x2.2 m, bei einem hubmoment von 28 t*m und einer hydr. Reichweite von 25,76 m.
- Compacto 25,76 m. De brazo hidr(ulico 28 t*m de capacidad en un espacio de 1x2.5x2.2 m



- Filtro ad alta pressione con spia luminosa di intasamento sul pannello di controllo.
- Warning light that informs the operator when the high pressure filter is clogged.
- Filtre haute pression avec témoin de colmatage sue le tableau de contrôle.
- Verschmutzungsanzeige des Hochdruckfilter durch Warnlicht.
- Filtro de alta presión con avisador luminoso de atascamiento en el panel del control.



- Indicatore dello stato di carico con evidenziate le zone di preallarme e allarme come richiesto dalle normative internazionali.
- Load-status indicator with warning pre-warning indicator.
- Indicateur de l'état de la charge indiquant la zone de surcharge et d'approche de la surcharge selon les normes internationales.
- Lastmomentanzeiger mit automatischer Überlastvorwarnung.
- Indicador del estado de carga con evidencia de zonas de prealarma, según normativas internacionales.

- Il serbatoio e tutti i carter di protezione sono in acciaio inox. Un filtro d'aria e d'olio nel serbatoio assicura la massima pulizia dell'impianto.
- The oil tank as well as all other protections are made out of stainless steel. The oil is kept free of pollution by a air filter and a return line filter.
- Réservoir d'huile et carter de protection en acier inoxydable, avec filtres à air et à huile assurant le nettoyage du circuit hydraulique.
- Öltank und Schutzbleche sind aus Edelstahl Das Öl wird durch einen Luftfilter und einen Rück aufölfilter vor Verunreinigung geschützt.
- El deposito y todos los cartees de protección son de Acero Inox. Un filtro de aire y de aceite en el deposito asegura la máxima limpieza de la instalación.

- Braccio esagonale in materiale ultra resistente; rottura garantita minima pari a 980 N/mm² (140.000 psi) con una unica saldatura nella parte compressa.
- Hexagonal boom section made out of high strength steel. Minimum braking point equal to 980 N/mm² (140000 psi). The boom has only one welding.
- Braz à section hexagonale en acier haute résistance: rupture minimum garantie égale à 980 N/mm² (140000 psi) avec une seule soudure dans la partie comprimée.
- Hexagonalausleger (Sechskant) aus hochwertigem Feinkornstahl. Min. Zugfestigkeit 980 N/mm² (140000 psi). Der Ausleger hat nur eine Schweißnaht.
- Brazo hexagonal de material ultraresistente; rotura mínima garantizada equivalente a 980N/mm² (140000 psi) con una unica soldatura en la parte comprimida.

- Tutte le parti in movimento ed i tubi sono ricoperti da pannelli di protezione come richiesto dalle normative sulla sicurezza.
- All moving parts as well as hoses are covered with protection panels.
- Toutes les parties mobiles ainsi que les tuyaux sont protégés par des panneaux de protection selon les normes de sécurité.
- Alle beweglichen Teile und alle Hydraulikschläuche sind durch Abdeckungen geschützt.
- Todas las partes en movimiento y los tubos están recubiertos de paneles de protección, según normativas de seguridad.



SERIE 27500 A.S.C.plus

Stabilizzatori extralargo con cilindri di estensione protetti.
Wide outriggers extension with protected cylinders.
Stabilisateur avec grande extension et vérins protégés.
Gross abstützbreite mit abgedeckten abstützgliedern.
Estabilizadores super-anchos marplatés de extensión protegidos.

Limitatore di momento per prevenire sovraccarichi accidentali.
Overload protection, to prevent overloading.
Limiteur de capacité pour prévenir surcharges.
Zur Vermeidung von überlast der kran ist mit einer überlast-abschuhvorrichtung ausgerüstet werden.
Limitador de momento para evitar sobrecargas.

Bacche in materiale autolubrificante.
Buckets made in self-lubricating material.
Bâches en matériel auto-lubrifiant.
Büchsen aus selbstschmierendem Material.
Los casquillos están fabricados con material autolubrificante.

Rotazione tramite motore idraulico, riduttore e freno ad intervento negativo, possibilità di avere la rotazione continua (in opzione).
Kri rotatione 420° in opzione.

The crane swings thanks to a rotation system made out of an hydraulic motor a negative disc brake and a gear box. The crane can be equipped with a continuous rotation system. (Option 420°)

Rotation mediante motor hidráulico, reductor y freno de intervención negativa, posibilidad de obtener rotación continua o 420° (leigo pedido).

Das Schwenkwerk wird über ein Getriebe durch einen Hydraulikmotor angetrieben. Gebremt wird es durch eine Scheibenbremse. Der Kran kann mit einem endlos drehbaren Schwenkwerk ausgerüstet werden. (Option 420°)

Rotación mediante motor hidráulico, reductor y freno de intervención negativa, posibilidad de obtener rotación continua o 420° (leigo pedido).

Cuscinetto di base a rulli, massima resistenza, precisione di movimento, minimo attrito, nessuna usura.
Highly resistant base roller bearing, outstanding motion precision, very little friction, no wear.

Couronne à rouleaux pour obtenir résistance maximume, précision de mouvement, minimume friction et pas d'usage.

Der stützrollengelegene Dreikranz ermöglicht feinfühligste bewegungsabläufe, erzeugt niedrige reibung und ist ausserst verschleißes.

Rodamientos de base en rodillos, máxima resistencia, precisión de movimientos y mínima fricción, ningún desgaste.

Attacco al telaio oscillante in conformità alle specifiche dei maggiori costruttori di veicoli industriali.
3 point linkage as required by the leading truck manufacturers.

Alellaga à trac points en conformité aux prescriptions des principaux constructeurs de véhicules industriels.

3 punkt torsionsbrücke nach den aufbauvorschriften der führenden LKW hersteller.

Enganche al bastidor oscilante según recomiendan los principales constructores de vehículos industriales.

Perni in acciaio speciale.
Pins in special steel.
Boizen aus spezialstahl.
Pernos en aceri especial.

Massima potenza, n° 2 cilindri di sollevamento per maggior resistenza.
Outstanding power, 2 lifting cylinders granting lighter resistance.
Puissance maximume, n°2 vérins de levage pour obtenir plus résistance.
2 Hauptzylinder erzeugen eine gleichmässige hubkraft und garantieren eine hohe betriebssicherheit.
Maxima potencia, n° 2 cilindros para levantar y para mayor resistencia.

Braccio sovrapposto con sezione chiusa, massima resistenza a torsione e massima leggerezza della struttura.
Shaped arm with closed section, max. resistance to torsional stress, and light structure.
Bras faconné à coupe fermée permettant d'obtenir haute résistance à la torsion et structure très légère.
Durch die geschlossene konstruktion des hubarmes, wird eine hohe verarbeitbarkeit bei geringem eigeigenwicht erreicht.
El perfil del brazo es de sección cerrada para alcanzar la máxima resistencia en los esfuerzos de torsión, con una estructura ligera.

Course de télescopic extralarge pour une extrême stabilité hydraulique (27500 E6 F64).

Télescopic cylinders with very long stroke for a maximum hydraulic range of 25,76 m (27500 E6 F64).

Course des vérins télescopiques très longue pour une détente du bras hydraulique de mètres max. 25,76 m (27500 E6 F64).

Superlanger teleskopaussschub für eine reichweite von 25,76 m (27500 E6 F64).

Carrera extra larga de los teles(cipos para una extensión hidráulica máxima de 25,76 m (27500 E6 F64).

Valvola flapante sui cilindri per maggior sicurezza.
Flanged valve on the cylinder for > safety.

Souape de sûreté flasquée sur les vérins pour obtenir plus sécurité.

Druck geflanschte ventile für ihre sicherheit.

Valvula antiretomo para mayor seguridad.

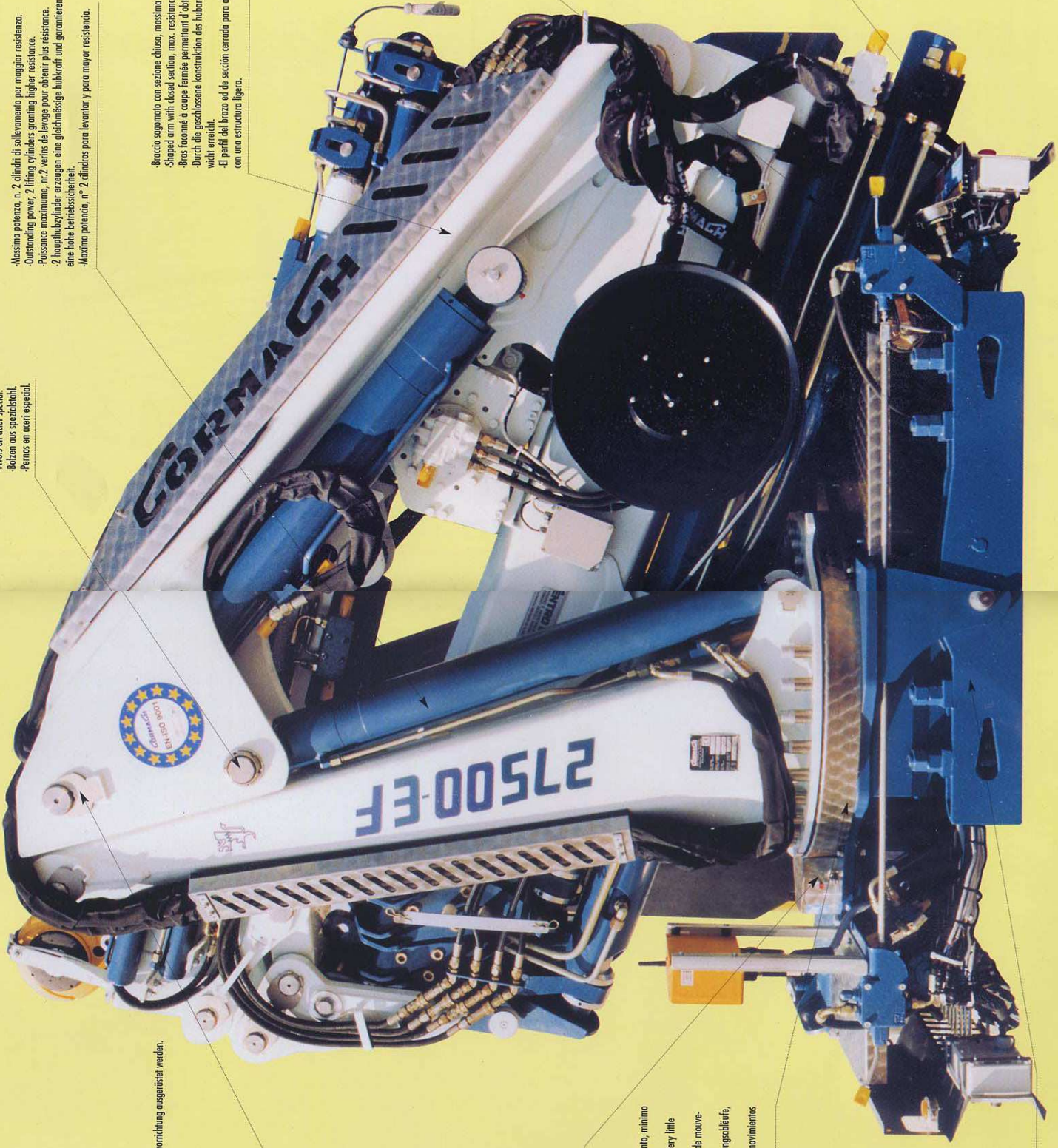



- In opzione alla gru e' possibile richiedere una piattaforma di lavoro con la quale si puo' arrivare fino ad una altezza max. di 24 m.
- The crane can be equipped with a men basket. Max. working height 24 m.
- En option, la grue peut être équipée d'une nacelle pouvant atteindre une hauteur d'environ 24 m.
- Personenkorb als Zubehör lieferbar. Max. Arbeitshöhe: 24 m.
- Bajo pedido se puede conseguir una plataforma aérea de trabajo que puede llegar hasta una altura máxima de 24 m.

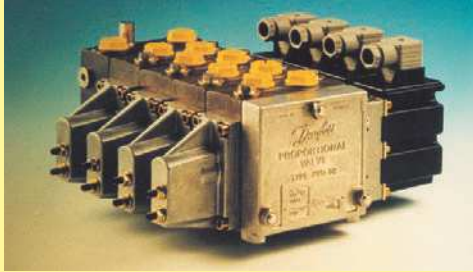

- Distributore proporzionale danfoss di serie. Ottimizza il flusso di olio permettendo di compiere più manovre contemporaneamente.
- The crane is equipped with a Danfoss proportional control valve (flow and pressure compensated). For more functions at the same time.
- Distributeur proportionnel DANFOSS.
- Der Kran ist mit einem Danfoss multifunktion Proportional Ventil ausgerüstet werden.
- Distribuidor proporcional DANFOSS.



- Argano con fune antigiro da 1500 kg, possibilità' di chiudere la gru senza smontare la testata
- The crane is equipped with a 1500 Kg winch with no spinning wire rope. The crane can be folded with installed horse head.
- Disponibile en option: treuil hydraulique, capacité 1500 Kg, avec câble anti-giratoire et possibilité de replier la grue sans démonter la tête de flèche.
- Der Kran kann mit einer 1500 kg Seilwinde (Option) ausgerüstet werden. Er kann mit dem montierten Rollenkopf zusammengelegt werden.
- Cabrestantes con cuerda antigiro de 1.500 kG, posibilidad de cerrar la grua sin desmontar la cabeza.



- Pannello di controllo con spia luminosa di intasamento filtro e conta-ore fondamentale per la programmazione della manutenzione.
- Instrument board with hour meter and filter clogging indicator. Fundamental for maintenance programming.
- Tableau de contrôle avec témoin de colmatage du filtre haute pression et compteur horaire. Cet équipement est fondamental pour la programmation des entretiens périodiques.
- Armaturenbrett mit Stundenzähler und Verschmutzungsanzeige des Hochdruckfilters. Unbedingt notwendig für eine sinnvolle Wartung des Krans.
- Panel de control con avisador luminoso de atascamiento filtro y cuenta horas, muy importante para la programación del mantenimiento.

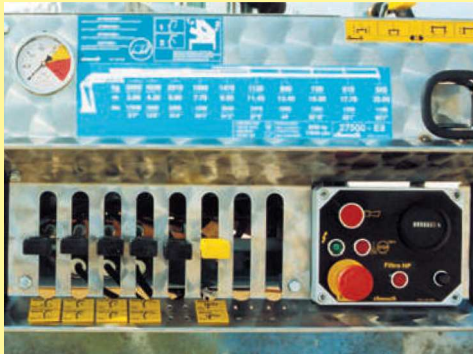

- Posto di manovra in armonia con tutte le normative riguardanti l'ergonomia e la sicurezza e completo di bolla per il posizionamento in piano della gru.
- Control board made in accordance with all norms for both ergonomic and safety. It is also equipped with a water level.
- Siège de commande sur colonne, en harmonie avec les normes de sécurité et d'ergonomie, complété d'un niveau à bulle.
- Die Bedienungselemente sind nach ergonomischen und sicherheitstechnischen Aspekten angeordnet. Zur Ausrichtung des Krans ist er mit einer Libelle ausgerüstet.
- Puesto de maniobra según normativas que se refieren a la ergonomía, seguridad y accesorio para el posicionamiento en plano de la grua.



- Radiocomando con raggio d'azione di 100 m di serie; completo di carica-batterie e di collegamento a cavo (senza emissione di onde radio) per uso in emergenza nel caso di mal funzionamento del radio o delle batterie.
- Radio remote control with 100 m. of working radius, equipped with battery charger, and cable (the sender controls the crane with cable, without emission of radio signals). The cable can be used in case of batteries failure.
- Radiocommande d'un rayon d'action de 100 m. Livrée avec chargeur de batterie et câble de raccordement de secours (sans ondes radio) pour utilisation dans les zones non autorisées en radiocommande ainsi qu'en cas de défaillance du mode radio.
- Der kran ist mit eine Funkanlage (100m Reichweite) geliefert. Sie ist zusätzlich mit einer Kabelsteuerung versehen werden (keine Funksignale). Dies ist notwendig um in der Nähe von Krankenhäuser etc. zu arbeiten.
- Radiomando con radio de acción de 100 mts.; completa de carga-baterías y de botonera por cable (sin emisión de ondas radio) para uso de emergencia en caso de mal funcionamiento del radiomando o bien de las baterías.



- Certificazione totale dalla saldatura al prodotto finito.
- The welding procedure is fully certified and is regularly re-qualified.
- Certification totale depuis les soudures jusqu'au produit fini.
- Die Schweißverfahren sind zertifiziert. Die Prüfungen werden regelmäßig wiederholt.
- Certificación total desde la soldadura hasta producto terminado.



- Progettazione su CAD-3D.
- Engineered with 3D CAD.
- Projectée par CAD-3D.
- Berechnet mit 3D CAD.
- Projectada con CAD 3D.

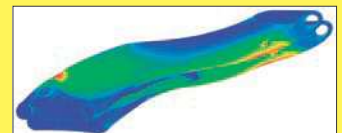

- Strutture verificate con calcolo ad elementi finiti.
- Structures are verified with finite elements calculation.
- Structure vérifiée par calculs préalables tenant compte des contraintes appliquées aux différents éléments en utilisation réelle.
- Die Struktur des Krans wurde mit finiten Berechnungen (3-D CAD) kalkuliert.
- Estructura verificadas con calculo de elementos acabados.

27500-E2

A.S.C.plus

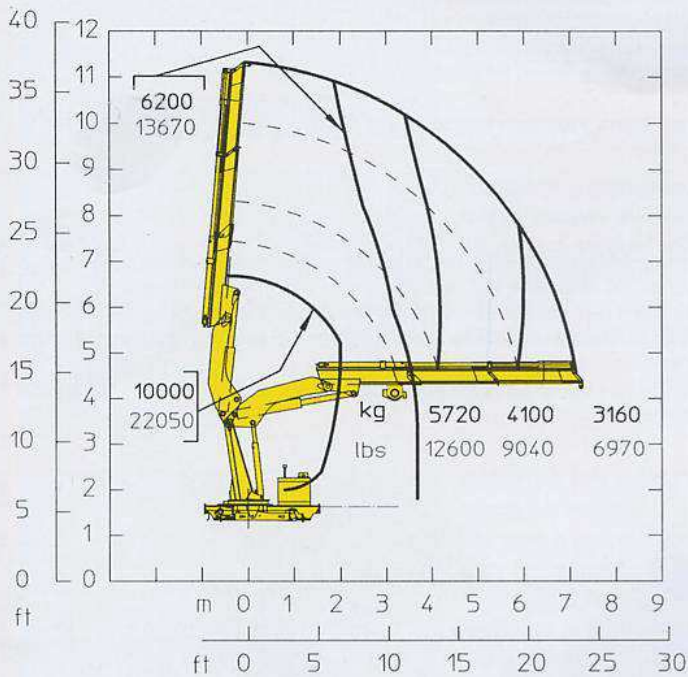

27500-E4

A.S.C.plus

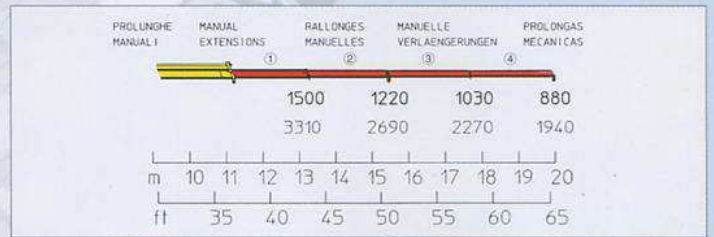
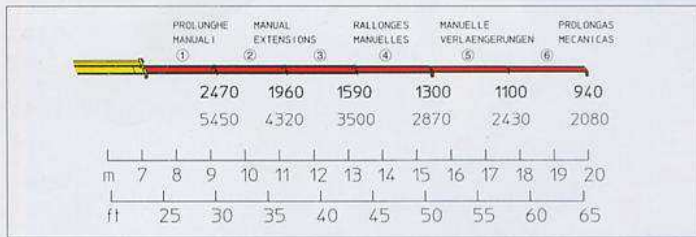
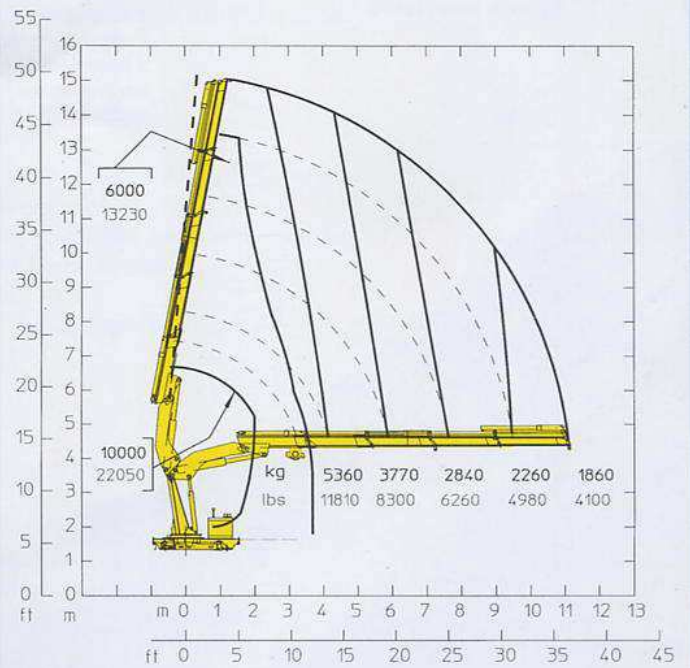

STANDARD



OPTIONAL

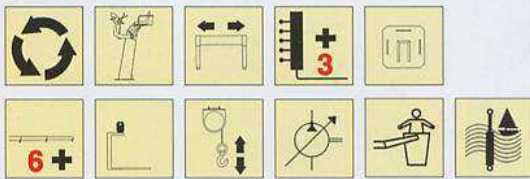

STANDARD



OPTIONAL

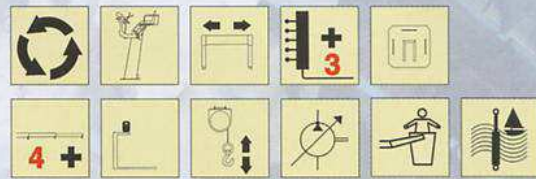

E2	E2		E4	E4
28000 daN • m	202560 lbs • ft	Momento statico massimo al perno torretta - Max. static moment at the turret pin - Moment statique max. à l'axe de la tourelle - Max. statisches Hubmoment am Kransaulenbolzen	28000 daN • m	202560 lbs • ft
7,4 m	24'3"	Sbraccio idraulico - Hyd. boom length - Longueur du bras Hyd. - Hyd. Reichweite	11,3 m	37'1"
20,0 m	65'7"	Sbraccio con prolunghe manuali - Boom length with manual extensions - Longueur du bras avec rallonges manuelles - Auslegerlänge - Longitud del brazo hidráulico con prolongas manuales	20,0	65'7"
2800 daN • m	20260 lbs • ft	Coppia di rotazione - Slew torque - Moment de rotation - Drehmoment	2800 daN • m	20260 lbs • ft
40 sec - 360°	40 sec - 360°	Tempo di rotazione - Slewing speed - Temp de rotation - Schwenkgeschwindigkeit	40 sec - 360°	40 sec - 360°
1750+1750 mm	5'9" x 5'9"	Uscita stabilizzatori - Outriggers extension - Sortie des bequilles - Breite der Abstützung	1750+1750 mm	5'9" x 5'9"
5838 mm	19'2"	Larghezza stabilizzatori - Outriggers width - Largeur des bequilles - Gesamtbreite der Abstützung	5838 mm	19'2"
1007 mm	3'4"	Lunghezza - Outriggers - Largeur - Gesamtbreite - Ancho	1007 mm	3'4"
2500 mm	8'2"	Larghezza - Width - Largeur - Breite	2500 mm	8'2"
2230 mm	7'4"	Altezza - Height - Hauteur - Höhe	2230 mm	7'4"
2760 Kg	6090 Lbs	Peso (senza olio e montaggio) - Weight (without oil and fitting) - Poids (sans huile et montage) - Gewicht (ohne Öl und ohne)	3080 Kg	6790 Lbs
55 lit / min	14,5 us gal/min	Portata pompa - Pump delivery - Capacité de la pompe - Pumpenleistung	55 lit / min	14,5 us gal/min
300 bar	4270 psi	Pressione - Pressure - Pression - Druck	300 bar	4270 psi
155	41 us gal	Capacità serbatoio olio - Oil tank capacity - Capacité du réservoir d'huile - Öl tank inhalt - Aceite	155	41 us gal

27500-E6

A.S.C.plus

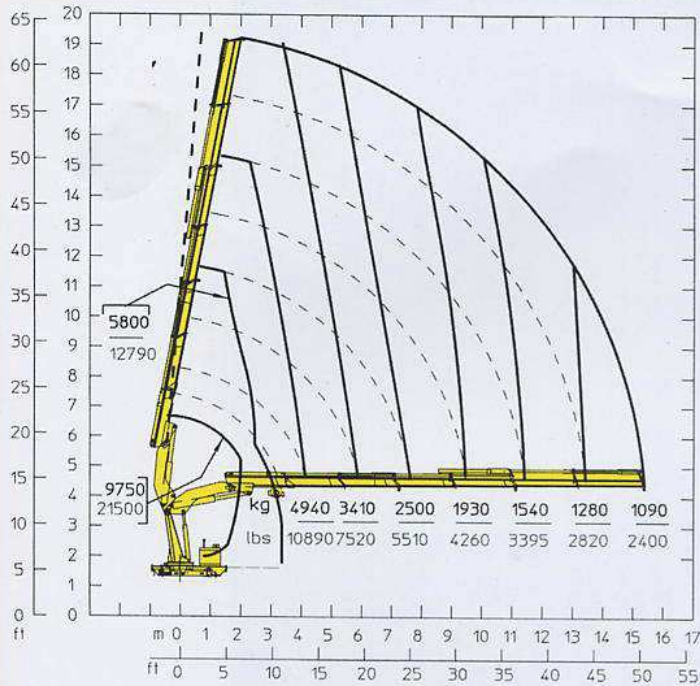

27500-E8

A.S.C.plus

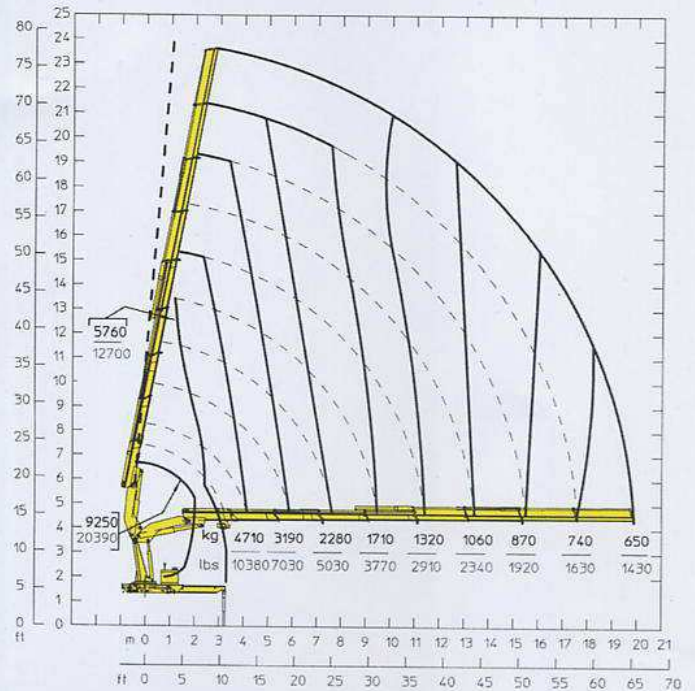

PROLONGHE MANUALI	MANUEL EXTENSIONS	RALLONGES MANUELLES	MANUELLE VERLÄNGERUNGEN	PROLONGAS MECANICAS
		①	②	
		Kg	920	780
		Lbs	2030	1720
		m	13 14 15 16 17 18 19 20	
		ft	45 50 55 60 65	

STANDARD



OPTIONAL

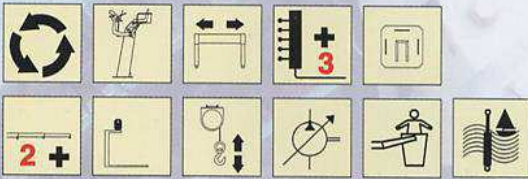

STANDARD



OPTIONAL

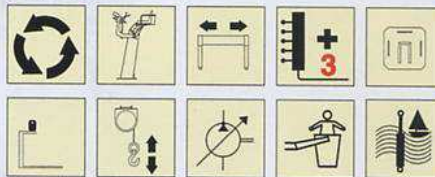

E6	E6		E8	E8
28000 daN • m	202560 lbs • ft	Momento statico massimo al perno torretta - Max. static moment at the turret pin - Moment statique max. à l'axe de la tourelle - Max. statisches Hubmoment am Kransaulenbolzen	28000 daN • m	202560 lbs • ft
15,54m	50'12"	Sbraccio idraulico - Hyd. boom length - Longueur du bras Hyd. - Hyd. Reichweite	20,0 m	65'7"
20,0 m	65'7"	Sbraccio con prolunghe manuali - Boom length with manual extensions - Longueur du bras avec rallonges manuelles - Auslegerlänge - Longitud del brazo hidráulico con prolongas manuales	/	/
2800 daN • m	20260 lbs • ft	Coppia di rotazione - Slew torque - Moment de rotation - Drehmoment	2800 daN • m	20260 lbs • ft
40 sec - 360°	40 sec - 360°	Tempo di rotazione - Slewing speed - Temp de rotation - Schwenkgeschwindigkeit	40 sec - 360°	40 sec - 360°
1750+1750 mm	5'9"+5'9"	Uscita stabilizzatori - Outriggers extension - Sortie des bequilles - Breite der Abstützung	1750+1750 mm	5'9"+5'9"
5838 mm	19'2"	Larghezza stabilizzatori - Outriggers width - Largeur des bequilles - Gesamtbreite der Abstützung	5838 mm	19'2"
1007 mm	3'4"	Lunghezza - Outriggers - Largeur - Gesamtbreite - Ancho	1007 mm	3'4"
2500 mm	8'2"	Larghezza - Width - Largeur - Breite	2500 mm	8'2"
2230 mm	7'4"	Altezza - Height - Hauteur - Höhe	2230 mm	7'4"
3390 Kg	7480 Lbs	Peso (senza olio e montaggio) - Weight (without oil and fitting) - Poids (sans huile et montage) - Gewicht (ohne Öl und ohne)	3610 Kg	7960 Lbs
55 lit / min	14,5 us gal/min	Portata pompa - Pump delivery - Capacité de la pompe - Pumpenleistung	55 lit / min	14,5 us gal/min
300 bar	4270 psi	Pressione - Pressure - Pression - Druck	300 bar	4270 psi
155	41 us gal	Capacità serbatoio olio - Oil tank capacity - Capacité du réservoir d'huile - Öl tank inhalt - Aceite	155	41 us gal

27500-E4F62

A.S.C.plus

27500-E4F63

A.S.C.plus

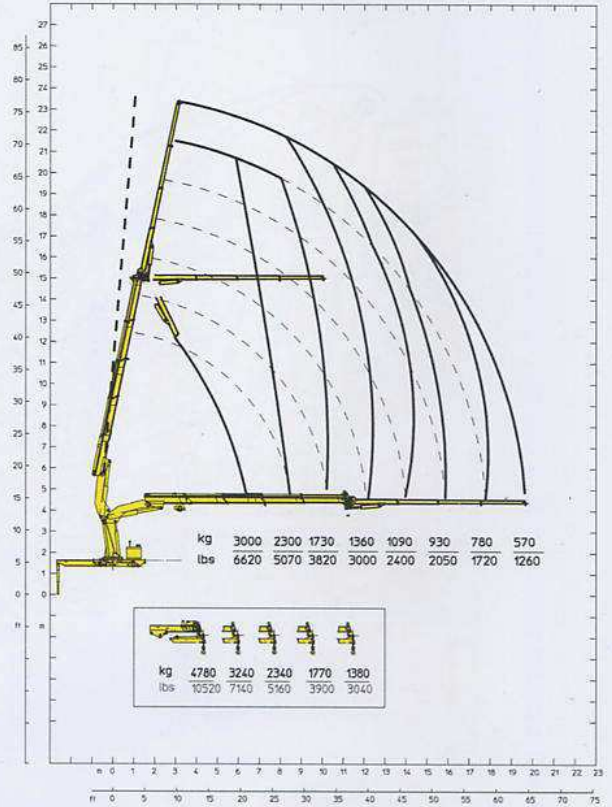
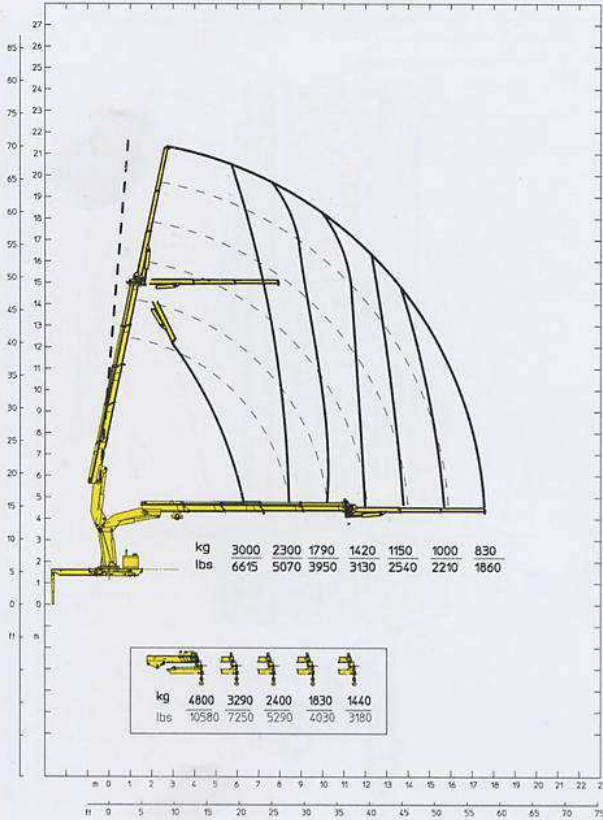

kg	2300	1230	830
lbs	5070	2710	1830

kg	2250	1180	780	570
lbs	4950	2600	1720	1260

STANDARD



OPTIONAL

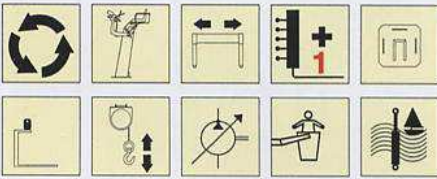

STANDARD



OPTIONAL

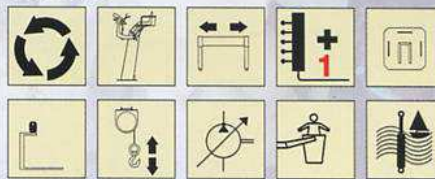

E4F62

E4F62

28000 daN • m	202560 lbs • ft
17,44 m	57'3"
/	/
2800 daN • m	20260 lbs • ft
40 sec - 360°	40 sec - 360°
1750+1750 mm	5'9"+5'9"
5838 mm	19'2"
1007 mm	3'4"
2500 mm	8'2"
2230 mm	7'4"
3730 Kg	8225 lbs
55 lit / min	14,5 us gal/min
300 bar	4270 psi
155	41 us gal

Momento statico massimo al perno torretta - Max. static moment at the turret pin - Moment statique max. à l'axe de la tourelle - Max. statisches Hubmoment am Kransaulenbolzen
Sbraccio idraulico - Hyd. boom length - Longueur du bras Hyd. - Hyd. Reichweite
Sbraccio con prolunghe manuali - Boom length with manual extensions - Longueur du bras avec rallonges manuelles - Auslegerlänge - Longitud del brazo hidráulico con prolongas manuales
Coppia di rotazione - Slew torque - Moment de rotation - Drehmoment
Tempo di rotazione - Slewing speed - Temp de rotation - Schwenkgeschwindigkeit
Uscita stabilizzatori - Outriggers extension - Sortie des bequilles - Breite der Abstützung
Larghezza stabilizzatori - Outriggers width - Largeur des bequilles - Gesamtbreite der Abstützung
Lunghezza - Outriggers - Largeur - Gesamtbreite - Ancho
Larghezza - Width - Largeur - Breite
Altezza - Height - Hauteur - Höhe
Peso (senza olio e montaggio) - Weight (without oil and fitting) - Poids (sans huile et montage) - Gewicht (ohne Öl und ohne)
Portata pompa - Pump delivery - Capacité de la pompe - Pumpenleistung
Pressione - Pressure - Pression - Druck
Capacità serbatoio olio - Oil tank capacity - Capacité du réservoir d'huile - Öl tank inhalt - Aceite

E6F63

E6F63

28000 daN • m	202560 lbs • ft
19,32 m	63'5"
/	/
2800 daN • m	20260 lbs • ft
40 sec - 360°	40 sec - 360°
1750+1750 mm	5'9"+5'9"
5838 mm	19'2"
1007 mm	3'4"
2500 mm	8'2"
2230 mm	7'4"
3790 Kg	8360 lbs
55 lit / min	14,5 us gal/min
300 bar	4270 psi
155	41 us gal

27500-E4F64

A.S.C.plus

27500-E6F62

A.S.C.plus

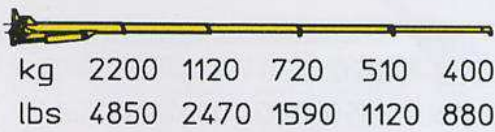
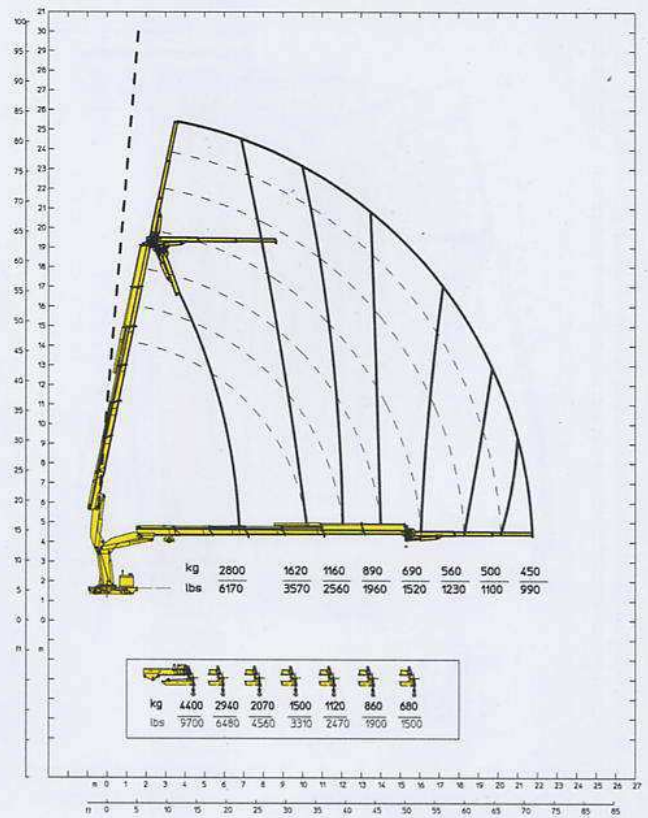
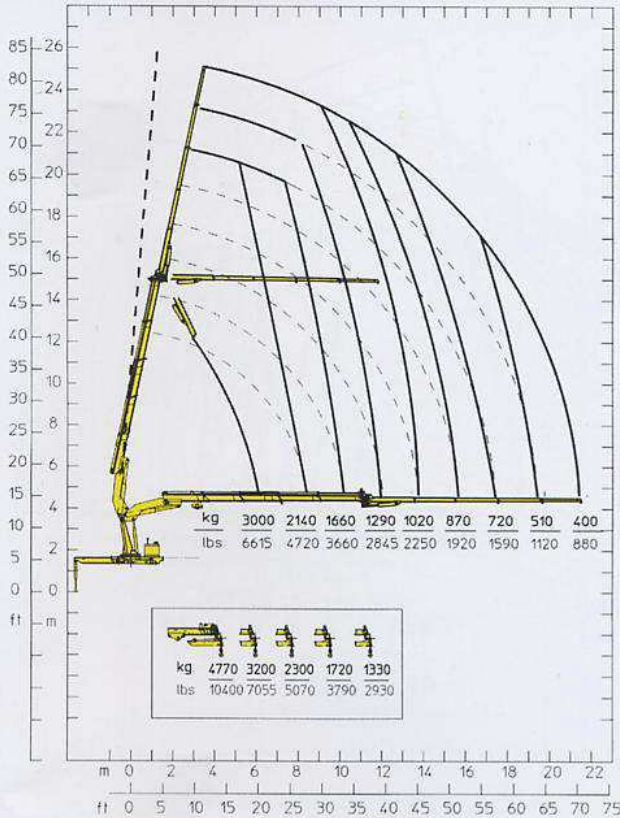

STANDARD



OPTIONAL

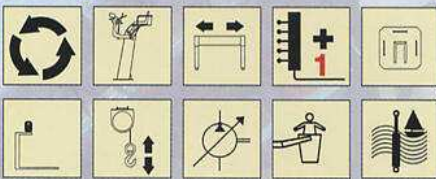

STANDARD



OPTIONAL

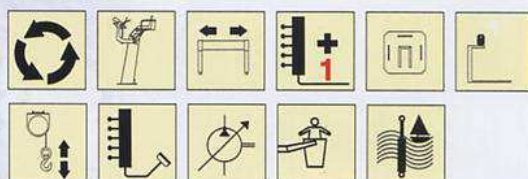

E4F64

28000 daN • m	202560 lbs • ft
21,40 m	70'3"
/	/
2800 daN • m	20260 lbs • ft
40 sec - 360°	40 sec - 360°
1750+1750 mm	5'9"+5'9"
5838 mm	19'2"
1007 mm	3'4"
2500 mm	8'2"
2230 mm	7'4"
3850 Kg	8490 Lbs
55 lit / min	14,5 us gal/min
300 bar	4270 psi
155	41 us gal

E4F64

Momento statico massimo al perno torretta - Max. static moment at the turret pin - Moment statique max. à l'axe de la tourelle - Max. statisches Hubmoment am Kransaulenbolzen
Sbraccio idraulico - Hyd. boom length - Longueur du bras Hyd. - Hyd. Reichweite
Sbraccio con prolunghe manuali - Boom length with manual extensions - Longueur du bras avec rallonges manuelles - Auslegerlänge - Longitud del brazo hidráulico con prolongas manuales
Coppia di rotazione - Slew torque - Moment de rotation - Drehmoment
Tempo di rotazione - Slew speed - Temp de rotation - Schwenkgeschwindigkeit
Uscita stabilizzatori - Outriggers extension - Sortie des bequilles - Breite der Abstützung
Larghezza stabilizzatori - Outriggers width - Largeur des bequilles - Gesamtbreite der Abstützung
Lunghezza - Outriggers - Largeur - Gesamtbreite - Ancho
Larghezza - Width - Largeur - Breite
Altezza - Height - Hauteur - Höhe
Peso (senza olio e montaggio) - Weight (without oil and fitting) - Poids (sans huile et montage) - Gewicht (ohne Öl und ohne)
Portata pompa - Pump delivery - Capacité de la pompe - Pumpenleistung
Pressione - Pressure - Pression - Druck
Capacità serbatoio olio - Oil tank capacity - Capacité du réservoir d'huile - Öl tank Inhalt - Aceite

E6F62

28000 daN • m	202560 lbs • ft
21,42 m	70'3"
/	/
2800 daN • m	20260 lbs • ft
40 sec - 360°	40 sec - 360°
1750+1750 mm	5'9"+5'9"
5838 mm	19'2"
1007 mm	3'4"
2500 mm	8'2"
2230 mm	7'4"
4030 Kg	8890 Lbs
55 lit / min	14,5 us gal/min
300 bar	4270 psi
155	41 us gal

E6F62

27500-E6F63

A.S.C.plus

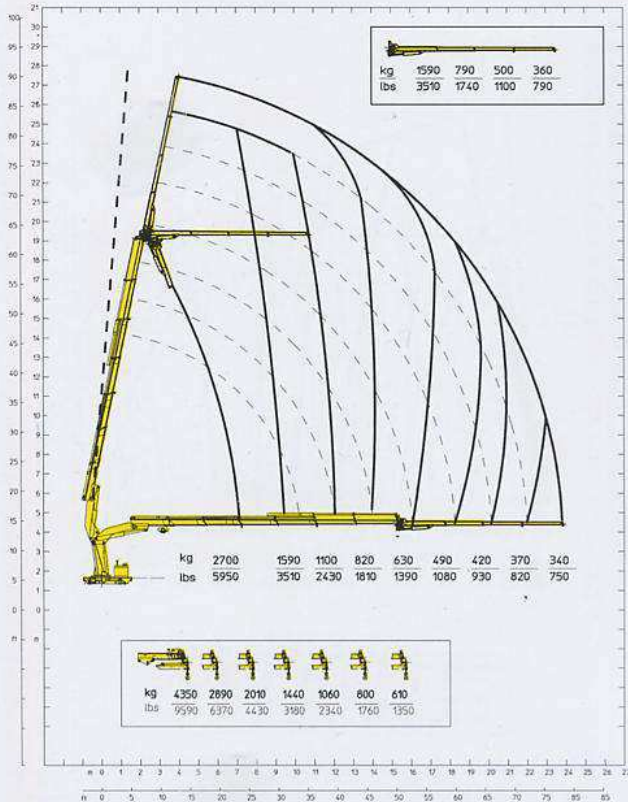

27500-E6F64

A.S.C.plus

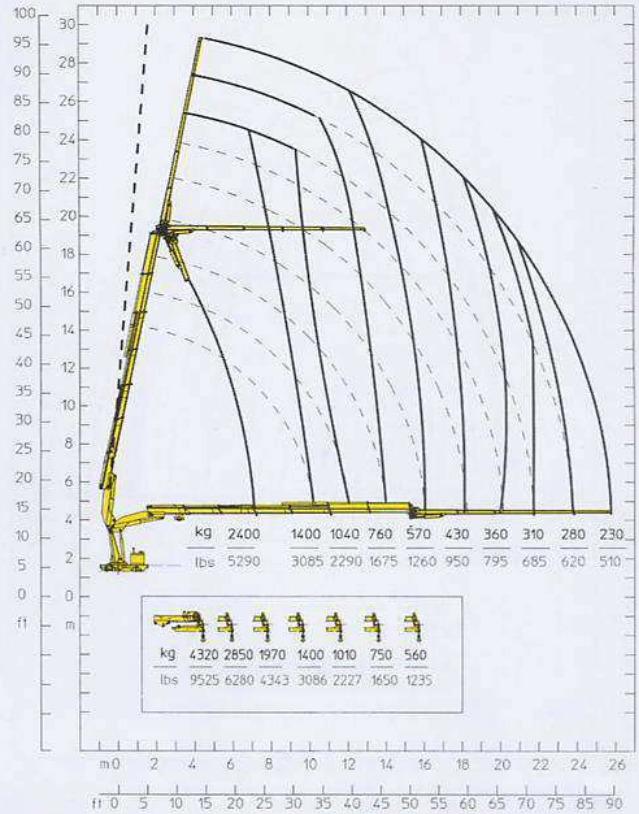

kg	1590	790	500	360
lbs	3510	1740	1100	790

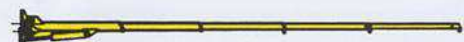

kg	1520	730	440	300	230
lbs	3350	1610	970	660	510

STANDARD



OPTIONAL

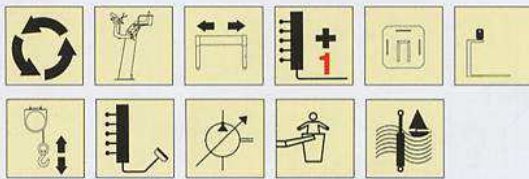

STANDARD



OPTIONAL



E6F63

E6F63

28000 daN • m	202560 lbs • ft
23,49 m	77'1"
/	/
2800 daN • m	20260 lbs • ft
40 sec - 360°	40 sec - 360°
1750+1750 mm	5'9"+5'9"
5838 mm	19'2"
1007 mm	3'4"
2500 mm	8'2"
2230 mm	7'4"
4090 Kg	9020 Lbs
55 lit / min	14,5 us gal/min
300 bar	4270 psi
155	41 us gal

Momento statico massimo al perno torretta - Max. static moment at the turret pin - Moment statique max. à l'axe de la tourelle - Max. statisches Hubmoment am Kransaulenbolzen
Sbraccio idraulico - Hyd. boom length - Longueur du bras Hyd. - Hyd. Reichweite
Sbraccio con prolungha manuali - Boom length with manual extensions - Longueur du bras avec rallonges manuelles - Auslegerlänge - Longitud del brazo hidráulico con prolongas manuales
Coppia di rotazione - Slew torque - Moment de rotation - Drehmoment
Tempo di rotazione - Slew speed - Temp de rotation - Schwenkgeschwindigkeit
Uscita stabilizzatori - Outriggers extension - Sortie des bequilles - Breite der Abstützung
Larghezza stabilizzatori - Outriggers width - Largeur des bequilles - Gesamtbreite der Abstützung
Lunghezza stabilizzatori - Outriggers - Largeur - Gesamtbreite - Ancho
Larghezza - Width - Largeur - Breite
Altezza - Height - Hauteur - Höhe
Peso (senza olio e montaggio) - Weight (without oil and fitting) - Poids (sans huile et montage) - Gewicht (ohne Öl und ohne)
Portata pompa - Pump delivery - Capacité de la pompe - Pumpenleistung
Pressione - Pressure - Pression - Druck
Capacità serbatoio olio - Oil tank capacity - Capacité du réservoir d'huile - Öl tank inhalt - Aceite

E6F64

E6F64

28000 daN • m	202560 lbs • ft
25,56 m	83'10"
/	/
2800 daN • m	20260 lbs • ft
40 sec - 360°	40 sec - 360°
1750+1750 mm	5'9"+5'9"
5838 mm	19'2"
1007 mm	3'4"
2500 mm	8'2"
2230 mm	7'4"
4150 Kg	9150 Lbs
55 lit / min	14,5 us gal/min
300 bar	4270 psi
155	41 us gal

GORMAGH 27500 A.S.C.plus

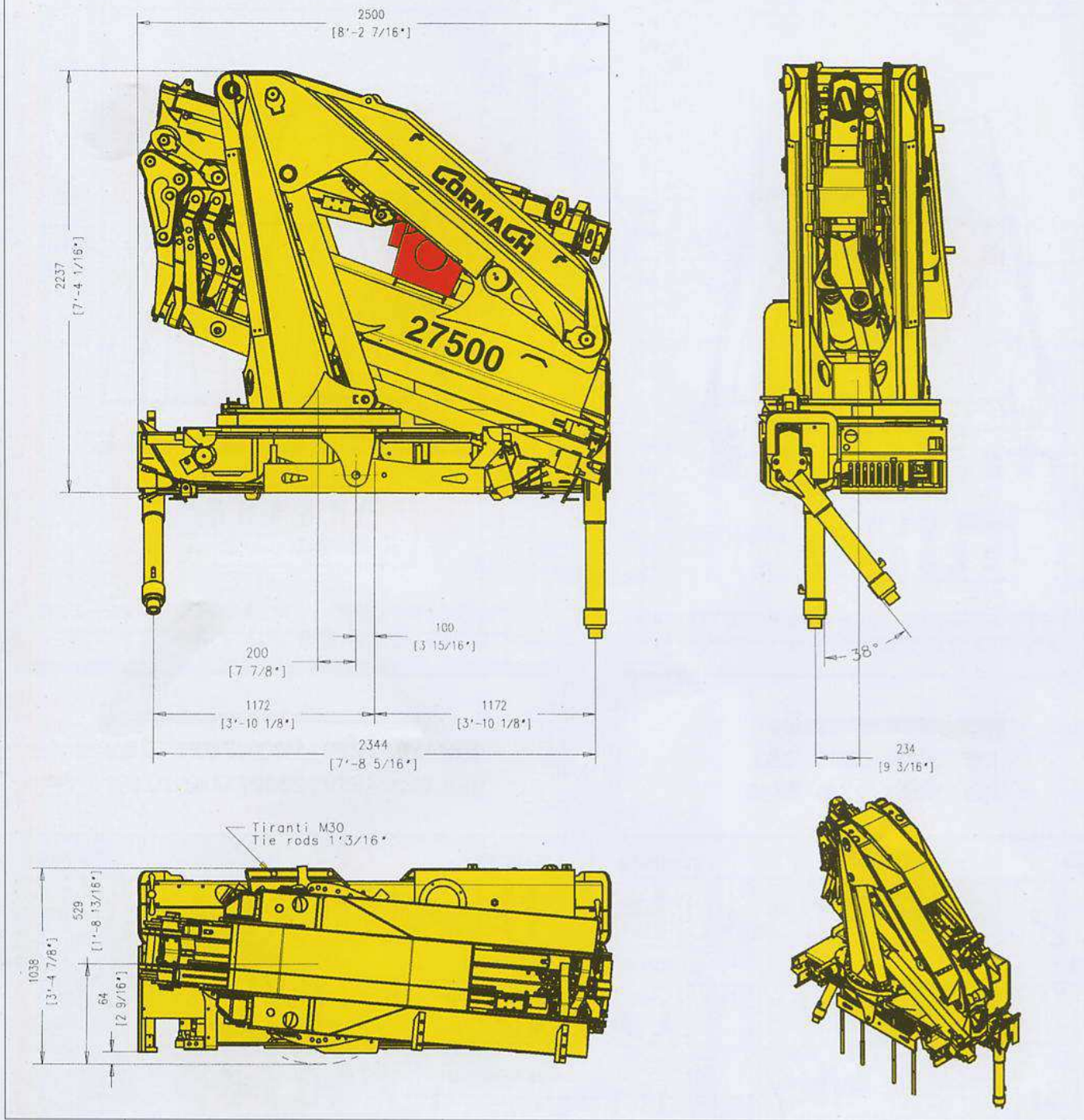

-A fronte di una continua ricerca tecnologica i dati possono cambiare senza preavviso. Contattare il nostro Ufficio Commerciale per ulteriori informazioni.
 -Because of continuous technology research data can change without notice. Please, contact our Commercial Dept. for further information.
 -A cause de une continue recherche technologique les données peuvent changer sans préavis. Contacter notre Bureau Commercial pour des autres informations.
 -Irrtum und technische änderung vorbehalten masse und gewichte unverbindlich. Unser Vertrieb erteilt innen gerne weitere Auskünfte. Bitte rufen Sie uns an.
 -Debido a los continuos avances tecnológicos los datos pueden variar sin notificación previa. Para más información rogamos contacten nuestro Departamento Comercial.

STANDARD

- 

Comandi bilaterali
Dual control stations
Commandes à gauche et à droite
Beidseitige Bedienung
Mandos bilaterales
- 

Limitatore di momento
Load limiting device
Limiteur de charge
Überlastabschaltung
Limitador de momento (de carga)
- 

Stabilizzatori gru base girevoli
Tilt up outriggers
Stabilisateurs tournant
Drehbare Stützen
Estabilizadores giratorios de la grua base
- 

Stabilizzatori gru base estendibili idraulicamente
Outriggers with hydraulic extension
Stabilisateurs avec extension hydraulique
Hydraulisch Ausfahrbare stützen
Estabilizadores grua base desplegables hidraulicamente
- 

Rotazione 360°
Rotation 360°
Rotation 360°
Drehbereich 360°
Rotación 360°
- 

Comando supplementare non attivato
Additional free section not activated
Section du distributeur pas activée
Zusätzlicher steuereheber
Mando auxiliar no activado
- 

Radiocomando
Radio remote control
Radiocommandes
Funkfernsteuerung
Radiomando

OPTIONAL

- 

Rotazione continua
Continuous rotation
Rotation continue
Endlos Schwenkwerk
Rotación continua
- 

Comando supplementare attivato
Additional function
Section du distributeur activée
Zusatzfunktion
Mando auxiliar activado
- 

Verricello
Winch
Treuil
Seilwinde
Cabrestante
- 

Treatmento marino della gru
Marine treatment of the crane
Traitement marin de la grue
Marine behandlung des Kranes
Tratamiento especial marino de la grua
- 

Posto di manovra in alto
Top seat
Siege en haut
Hochsitz
Puesto de maniobra en alto
- 

Piastre maggiorate
Large ground plates
Plaques stabilisateurs
Bodenplatten
Placas estabilizadoras de suelo de gran tamaño
- 

Pompa a portata variabile
Pump with load sensing
Pompe à débit variable
Verstellpumpe load sensing
Bomba de caudal variable
- 

Utilizzo con attrezzo
Additional accessories
Utilisation avec accessoire
Zubehör
Accesorios auxiliares
- 

Traversa ausiliaria estendibile
Additional outriggers with lateral extension
Stabilisateurs supplémentaires avec enlargementement
Ausfahrbare Zusatz-Stützen
Estabilizadores adicionales con extensión lateral
- 

Prolunghe meccaniche
Manual extensions
Rallonges manuelles
Manuelle Verlängerungen
Prolongas mecánicas
- 

Cestello
Basket
Nacelle
Personenkorb
Cesta



CORMACH

Cormach s.r.l. - Via Madonnina, 27 - C.P. 199 - 25018 MONTICHIARI (BS) - ITALY
Tel. 0039.030.9656811 - Telefax 0039.030.9656846.7.8
E-mail: info@cormach.com - www.cormach.com

A fronte di una continua ricerca tecnologica i dati possono cambiare senza preavviso. Contattare il nostro Ufficio Commerciale per ulteriori informazioni.
Because of continuous technology research data can change without notice. Please, contact our Commercial Dept. for further information.
A cause de une continue recherche technologique les données peuvent changer sans préavis. Contacter notre Bureau Commercial pour des autres informations.
Irrtum und technische Änderung vorbehalten. Unser Vertrieb erteilt Ihnen gerne weitere Auskünfte. Bitte rufen Sie uns an.
Debido a los continuos avances tecnológicos los datos pueden variar sin notificación previa. Para más información rogamos contactar nuestro Departamento Comercial.